

DIXIT RA4 RECESSED

E5604521

base number

1. To build a product code in our configurator select the specify button on the base model # product page
2. To build a manual product code on this datasheet choose from the options listed below in blue font and add the suffix to the base model #

GENERAL

Series: Dixit _____

Subseries: Dixit RA4 _____

Brand: Ivela _____

Division: Exterior _____

Mounting Type: Recessed _____

Mounting Location: Ceiling _____

Subcategory: Downlight _____

PHYSICAL

Shape: Round _____

Diameter (mm): 41 _____

Diameter (in): 1 ⁵/₈ _____

Height (mm): 45 _____

Height (in): 1 ³/₄ _____

Min. Recessing Depth (mm): 55 _____

Min. Recessing Depth (in): 2 ³/₁₆ _____

Light Distribution: Direct _____

Weight (kg): 0.1 _____

Weight (lbs): 0.22 _____

Diffuser: Clear polycarbonate _____

Fixture Finish: MWH _____

Fixture Material: Aluminum Die Cast _____

Cut-out Measurements: 36mm / 1 7/16" _____

ELECTRICAL

Lamp Type: LED _____

Total Output Wattage (W): 4.6 _____

Dimming: Non-Dimming / Phase Dimming (120Vac only) / 0-10V Dimming _____

Driver Included: No _____

Driver Location: Remote _____

Driver Type: Constant Current - 120 / 277Vac _____

Driver Class: Class 2 _____

Input Voltage (V): 120 - 277 _____

Constant Current (MA): 500 _____

LED

Color Temperature (°K): 3000 _____

Max. Delivered Lumen (lm): 320 _____

Efficiency (%): 59.3 _____

Lamp Life (hrs): 50000 _____

OPTICAL

Optic°: 60 _____

RATINGS AND CERTIFICATIONS

Certified By: Certified for North American Standards _____

IP rating: IP43 _____

IK Rating: IK07 _____



45mm (1 3/4")

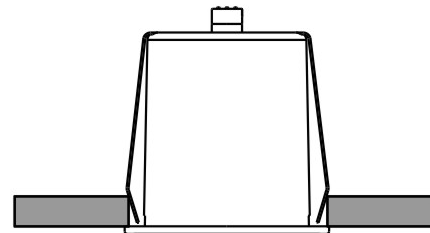

41mm (1 5/8")

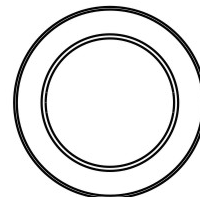

36mm (1 7/16")

E

DIXIT RA4 RECESSED

E5604521

PROJECT	
TYPE	
SPECIFIER	
QUANTITY	
DATE	

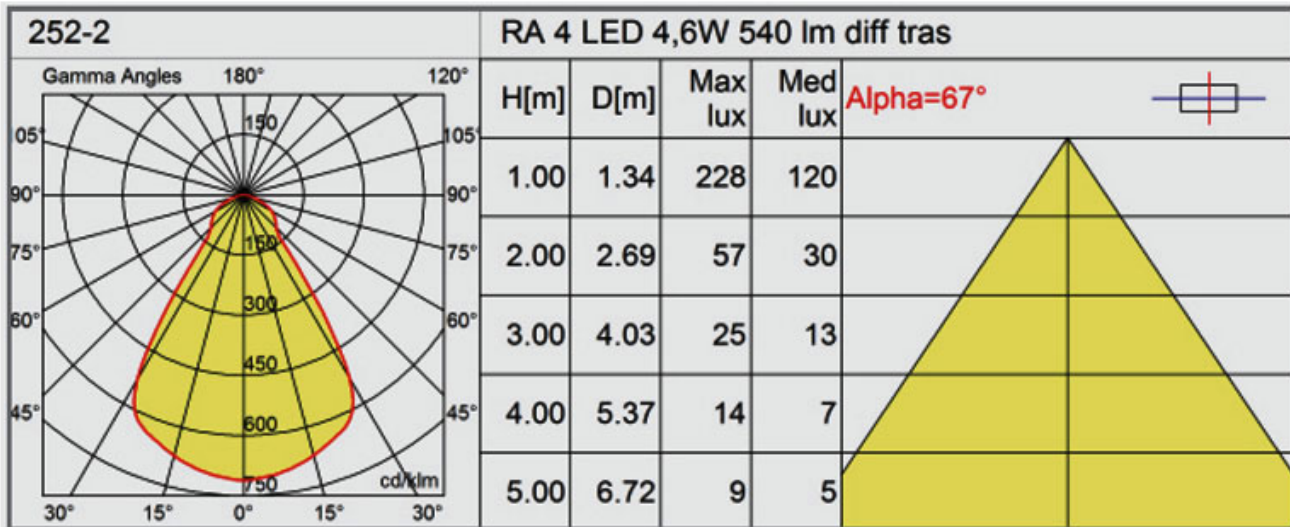
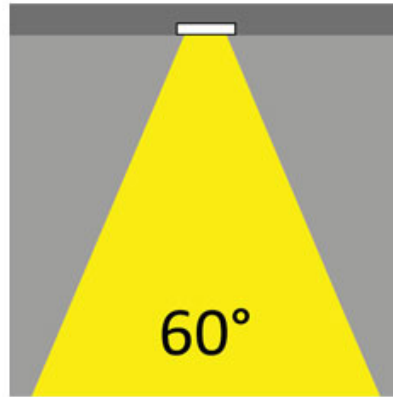

PROJECT	
TYPE	
SPECIFIER	
QUANTITY	
DATE	

DIXIT RA8 RECESSED

E56096-

base number Color
Temperature

- To build a product code in our configurator select the specify button on the base model # product page
- To build a manual product code on this datasheet choose from the options listed below in blue font and add the suffix to the base model #

GENERAL

Series: Dixit
Subseries: Dixit RA8
Brand: Ivela
Division: Exterior
Mounting Type: Recessed
Mounting Location: Ceiling
Subcategory: Downlight

PHYSICAL

Shape: Round
Diameter (mm): 95
Diameter (in): 3 3/4
Height (mm): 89
Height (in): 3 1/2
Min. Recessing Depth (mm): 129
Min. Recessing Depth (in): 5 1/16
Light Distribution: Adjustable / Direct
Weight (kg): 0.7
Weight (lbs): 1.54
Diffuser: Clear Polycarbonate
Fixture Finish: MWH
Fixture Material: Aluminum Die Cast
Cut-out Measurements: 86mm / 3 3/8"

ELECTRICAL

Lamp Type: LED
Total Output Wattage (W): 12
Dimming: Tri-Mode (Non-Dimming and Phase Dimming (120Vac only) and 0-10V Dimming)
Driver Included: No
Driver Location: Recessed Housing
Driver Type: Constant Current - Universal
Driver Class: Class 2
Housing: See Components
Input Voltage (V): 120 - 277
Constant Current (mA): 350

LED

Number of LEDs: 1
Color Temperature (°K): 2700 / 3000
Max. Delivered Lumen (lm): 1447
Nominal Lumen (lm): 1650
CRI: >80 CRI
Efficiency (%): 87.7
Lamp Life (hrs): 50000
Upon Request: 3500K upon request

OPTICAL

Reflector: Mirror-metallized thermoplastic material
Optic: 26
Beam Angle: Symmetric
Adjustability: Tilt ±20°
Upon Request: Optics 45° (mirror-metallized) / 65° (white)

RATINGS AND CERTIFICATIONS

Certified By: Certified for North American Standards
IP rating: IP66
IK Rating: IK08

Clearance: 129mm (5 1/16")
© 2024, T 1800-388-3382, F 416-247-9319, www.zaneen.com

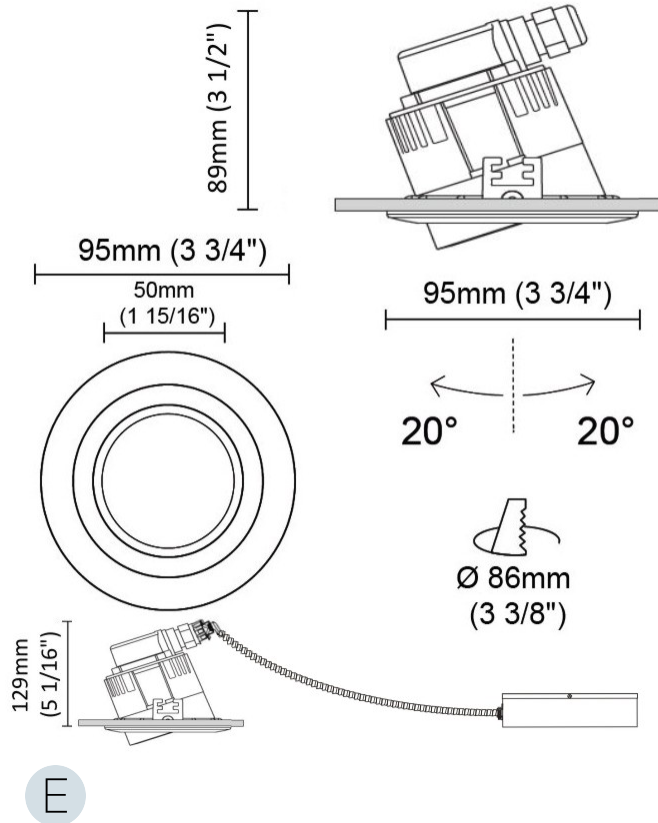

DIXIT RA8 RECESSED

E56096-

PROJECT	
TYPE	
SPECIFIER	
QUANTITY	
DATE	

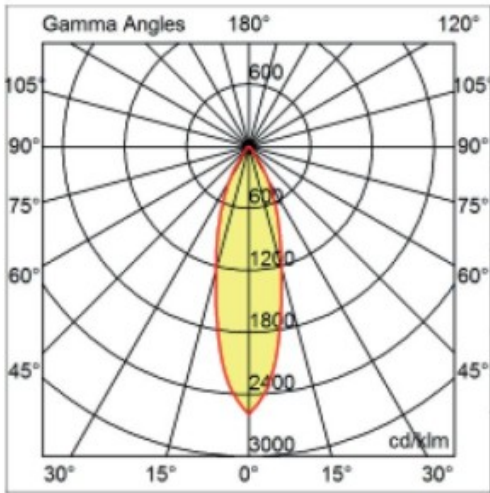

26°

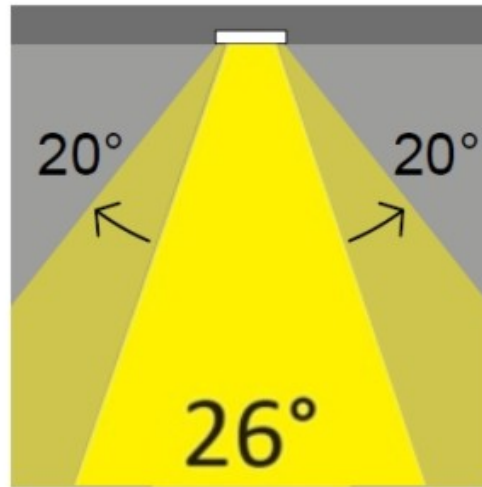

	DP	DV		Order Example		K°
Dimming	Phase	0-10V		L5XXXXXX-DV-30K		
Color Temperature	27K	30K	35K		0-10V	3000K
	2700K	3000K	3500K			

E

PROJECT	_____
TYPE	_____
SPECIFIER	_____
QUANTITY	_____
DATE	_____

DIXIT RA8 RECESSED

E56097-

base number _____ Color _____
Temperature _____

- To build a product code in our configurator select the specify button on the base model # product page
- To build a manual product code on this datasheet choose from the options listed below in blue font and add the suffix to the base model #

GENERAL

Series: Dixit
Subseries: Dixit RA8
Brand: Ivela
Division: Exterior
Mounting Type: Recessed
Mounting Location: Ceiling
Subcategory: Downlight

PHYSICAL

Shape: Round
Diameter (mm): 80
Diameter (in): 3 1/8
Height (mm): 50
Height (in): 1 15/16
Min. Recessing Depth (mm): 90
Min. Recessing Depth (in): 3 9/16
Light Distribution: Direct
Weight (kg): 0.4
Weight (lbs): 8.81
Diffuser: Clear Polycarbonate
Fixture Finish: MWH
Fixture Material: Aluminum Die Cast
Cut-out Measurements: 70mm / 2 3/4"

ELECTRICAL

Lamp Type: LED
Total Output Wattage (W): 5.5 / 8.5
Dimming: Tri-Mode (Non-Dimming and Phase Dimming (120Vac only) and 0-10V Dimming)
Driver Included: No
Driver Location: Recessed Housing
Driver Type: Constant Current - Universal
Driver Class: Class 2
Housing: See Components
Input Voltage (V): 120 - 277
Constant Current (MA): 350 / 500

LED

Number of LEDs: 1
Color Temperature (°K): 2700 / 3000 / 4000
Max. Delivered Lumen (lm): 501 - 638 / 592 - 729
CRI: >90 CRI
Efficiency (%): 91
Lamp Life (hrs): 50000
Upon Request: 3500K upon request

OPTICAL

Optic°: 26
Beam Angle: Symmetric
Adjustability: Fixed
Upon Request: Optics 45° (mirror metallized) / 65° (white)

RATINGS AND CERTIFICATIONS

Certified By: CSA Certified to UL and CSA Standards
IP rating: IP65
IK Rating: IK08

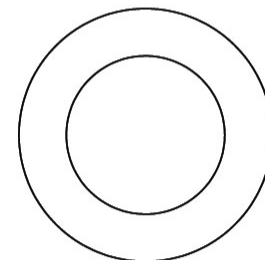
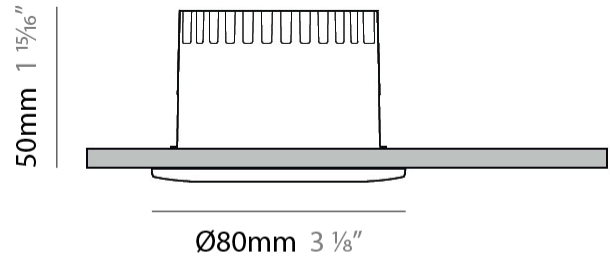

DIXIT RA8 RECESSED

E56097-

PROJECT	
TYPE	
SPECIFIER	
QUANTITY	
DATE	

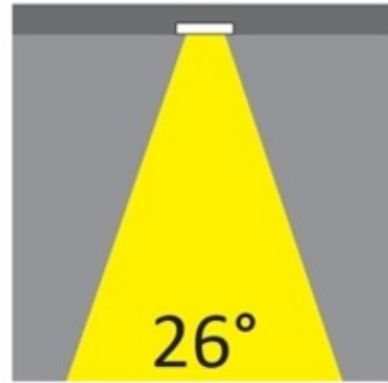
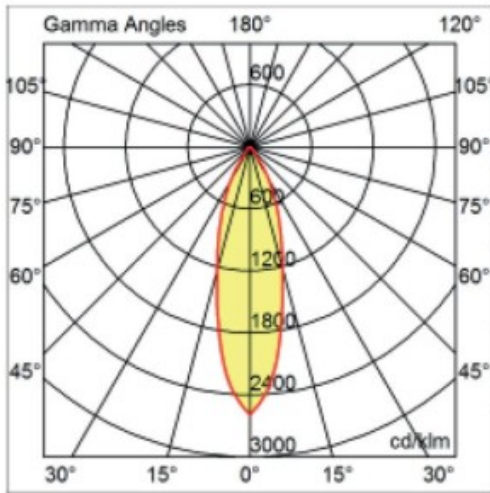

26°

Dimming	DP Phase	DV 0-10V		Order Example		K°
Color Temperature	27K 2700K	30K 3000K	35K 3500K	L5XXXXXX-DV-30K	0-10V	3000K

E

PROJECT	_____
TYPE	_____
SPECIFIER	_____
QUANTITY	_____
DATE	_____

DIXIT RA8 RECESSED

E56103-

base number _____ Color _____
Temperature _____

- To build a product code in our configurator select the specify button on the base model # product page
- To build a manual product code on this datasheet choose from the options listed below in blue font and add the suffix to the base model #

GENERAL

Series: Dixit
Subseries: Dixit RA8
Brand: Ivela
Division: Exterior
Mounting Type: Recessed
Mounting Location: Ceiling
Subcategory: Downlight

PHYSICAL

Shape: Round
Diameter (mm): 80
Diameter (in): 3 1/8
Height (mm): 81
Height (in): 3 3/16
Min. Recessing Depth (mm): 121
Min. Recessing Depth (in): 4 3/4
Light Distribution: Direct
Weight (kg): 0.4
Weight (lbs): 0.88
Diffuser: Clear Polycarbonate
Fixture Finish: MWH
Fixture Material: Aluminum Die Cast
Cut-out Measurements: 70mm / 2 3/4"

ELECTRICAL

Lamp Type: LED
Total Output Wattage (W): 9 / 12
Dimming: Tri-Mode (Non-Dimming and Phase Dimming (120Vac only) and 0-10V Dimming)
Driver Included: No
Driver Location: Recessed Housing
Driver Type: Constant Current - Universal
Driver Class: Class 2
Housing: See Components
Input Voltage (V): 120 - 277
Constant Current (MA): 250 / 350

LED

Number of LEDs: 1
Color Temperature (°K): 2700 / 3000 / 4000
Max. Delivered Lumen (lm): 1096 - 1140 / 1447 - 1491
CRI: >80 CRI
Efficiency (%): 87.7
Lamp Life (hrs): 50000
Upon Request: 3500K upon request

OPTICAL

Reflector: Mirror-metallized thermoplastic material
Optic: 26
Beam Angle: Symmetric
Adjustability: Fixed
Upon Request: Optic 45° (mirror-metallized) / 65° (white)

RATINGS AND CERTIFICATIONS

Certified By: Certified for North American Standards
IP rating: IP65
IK Rating: IK08
Glare Rating: ≤ 19

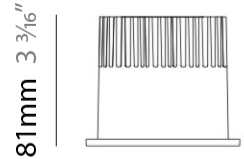

Ø80mm 3 1/8"

Ø50mm 2"

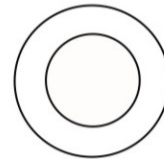

Ø70mm
2 3/4"

4 3/4"
121mm

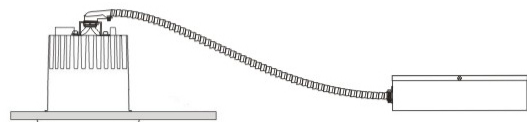

DIXIT RA8 RECESSED

E56103-

PROJECT	
TYPE	
SPECIFIER	
QUANTITY	
DATE	

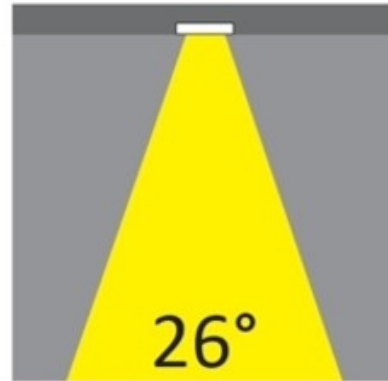
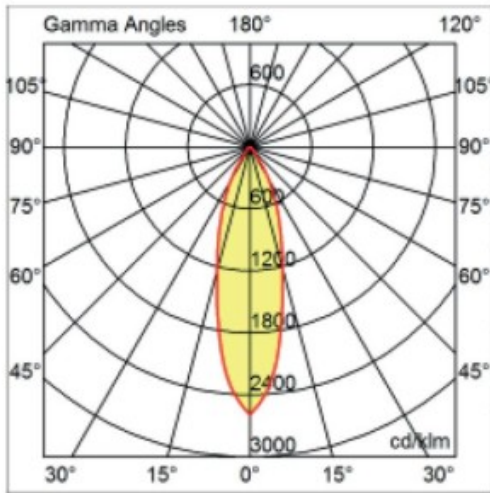

26°

Dimming	DP	DV	Order Example	K°
	Phase	0-10V		
Color Temperature	27K	30K	0-10V	3000K
	2700K	3000K		

E

PROJECT

TYPE

SPECIFIER

QUANTITY

DATE

Fixture Finish

Matte White - MWH



Digital: Not all screens are calibrated the same, and therefore, colors will appear differently between screens.

Physical: When texture is involved, there will be variations in color, character and tone within a product series and between product families.



PROJECT	
TYPE	
SPECIFIER	
QUANTITY	
DATE	

LEGEND

	floor-mounted		pivotable		special LED (upon request) RGB, RGBW, tunable, gold+, meat+, art+, fashion+
	wall and ceiling: recessed and surface mounted		rotating		warm dim / natural dimming LED
	ceiling-mounted and wall-mounted		illuminate tilted		rechargeable battery powered
	wall-mounted		color of suspension cable		fixture with natural vivid LED (upon request)
	omni-directional light distribution		length of suspension cable		color rendering index
	direct light distribution		reflector degree selection		color temperature
	direct/indirect light distribution		super spot		lumen (luminous flux)
	indirect light distribution		lens		efficacy (lumens per watt)
	asymmetric light distribution		lens pack		Unified Glare Rating (UGR) range from 5-40
	aura light distribution		shine ring		marine grade (AISI 316 stainless steel)
	round wall or ceiling cut-out		integrated shine ring with diffuser		walk on
	square wall or ceiling cut-out		free individual colors 01-29		drive on
	the supplied jig specifies the cutout dimensions		individual colors: 00 (free of charge), 01-25 (extra charge)		Dark Sky Compliance
	minimum distance (meters) lamp - object		luminaire part to be colored (F1)		Americans with Disabilities Act (less than 4" off the wall located between 27"-84" from floor)
	recessed depth		luminaire part to be colored (F2)		lamp protected against explosion
	ceiling thickness in mm		luminaire part to be colored (F3)		blown glass using traditional methods by master glass blower
	ceiling thickness selection		luminaire part to be colored (F4)		acoustic material
	dimmable DP (phase), DV (0-10V), DD (dali), DS (step-dim)		luminaire part to be colored (F5)		protection class I, protection insulation
	included or excluded LED driver/transformer/control gear		color of 3-circuit adaptor		protection class II, protection insulation
	separately switchable		indirect diffuser		ETL Certified to UL and CSA Standards
	sensor		direct diffuser		UL Certified to UL and CSA Standards
	remote control		ball-proof (upon request)		CSA Certified to UL and CSA Standards
	available upon request		accessory		Certified for North American Standards

IP RATING

	protected against ingress of solid bodies greater than 12.5mm (finger)
	protected against ingress of solid bodies greater than 2.5mm protected against sprays of water up to 60 degrees from the vertical (rain)
	protected against ingress of solid bodies greater than 1mm (wire) no protection against the ingress of moisture
	protected against ingress of solid bodies greater than 1mm (wire) protected against sprays of water up to 60 degrees from the vertical (rain)
	protected against ingress of solid bodies greater than 1mm (wire) protected against water splashed from all directions
	protected against limited ingress of dust (wet rooms/covered outdoor areas) protected against water splashed from all directions
	protected against ingress of dust protected against jets of water
	protected against ingress of dust protected against powerful jets of water or heavy seas
	protected against ingress of dust protected against immersion of water between 15cm - 1m for 30 minutes
	protected against ingress of dust protected against immersion of water under pressure for long periods

IK RATING

	protected against 0.14 joules impact (equivalent to 0.25kg mass dropped from 56mm above the surface)
	protected against 0.2 joules impact (equivalent to 0.25kg mass dropped from 80mm above the surface)
	protected against 0.35 joules impact (equivalent to 0.25kg mass dropped from 140mm above the surface)
	protected against 0.5 joules impact (equivalent to 0.25kg mass dropped from 200mm above the surface)
	protected against 0.7 joules impact (equivalent to 0.25kg mass dropped from 280mm above the surface)
	protected against 1 joules impact (equivalent to 0.25kg mass dropped from 400mm above the surface)
	protected against 2 joules impact (equivalent to 0.5kg mass dropped from 400mm above the surface)
	protected against 5 joules impact (equivalent to 1.7kg mass dropped from 300mm above the surface)
	protected against 10 joules impact (equivalent to 5.0kg mass dropped from 200mm above the surface)
	protected against 20 joules impact (equivalent to 5.0kg mass dropped from 400mm above the surface)